

WARNING!

Rewiring of fluorescent fixtures for use with LED tubes should only be performed by individuals who have been properly trained to perform basic electrical maintenance and repair. Please review these instructions thoroughly before proceeding!

Step 1: Before opening and disassembling the fixture, make sure power has been turned off at the main circuit breaker and remove the bulbs from the fixture.

Step 2: From the examples below, identify the wiring configuration of your fixture which is a function of the ballast type. There are three kinds fixture are used mainly, refer to the below configuration A, B or C.

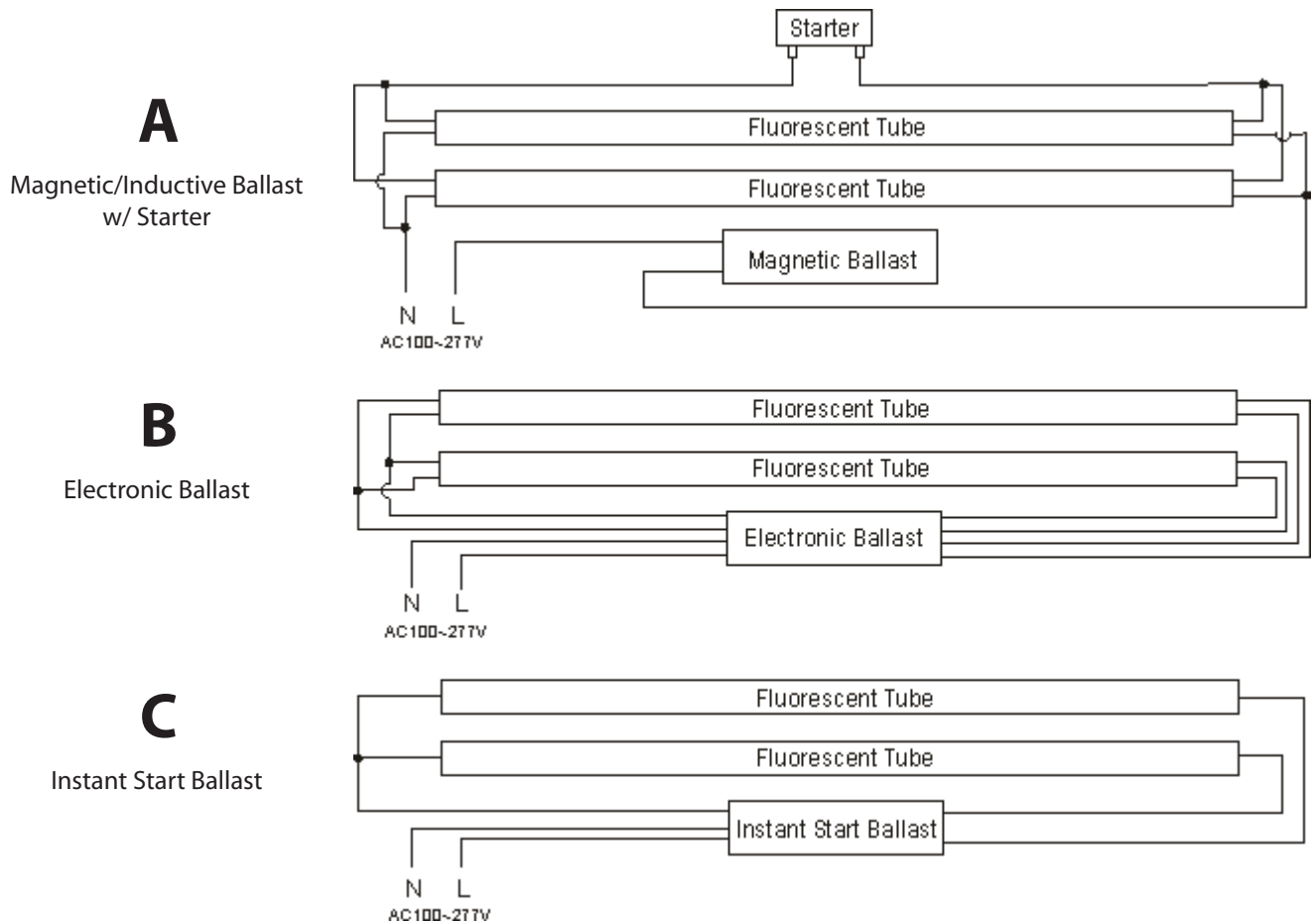

Step 3: The new LED tubes have one end with Live (L) and other end with Neutral (N) terminal pins as shown below. Before reconfiguring your wiring in next Step, make sure the wires going to the G13 socket that will hold the tube arranged so that live voltage connects to the side of the socket that will hold the L pins and that the neutral wire connects to the side of the socket that will hold the "N" pins.

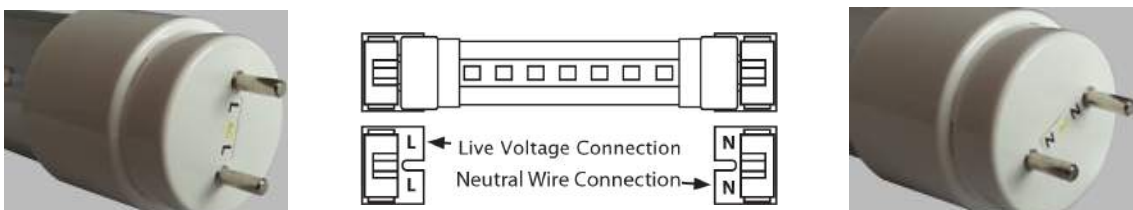

Step 4: Remove or disconnect all of the wiring/starter/ballast indicated in red in the diagrams below. When removing or cutting the wires from the fixture, make sure the sockets are tight in the fixture and will hold your new LED bulbs securely. If you elect to leave the starter, ballast, or cut wiring in the fixture, or if it cannot be removed easily, make sure that all unused lead wires are wire natted, rolled up, and secured out of the way.

A
Magnetic/Inductive Ballast
w/ Starter

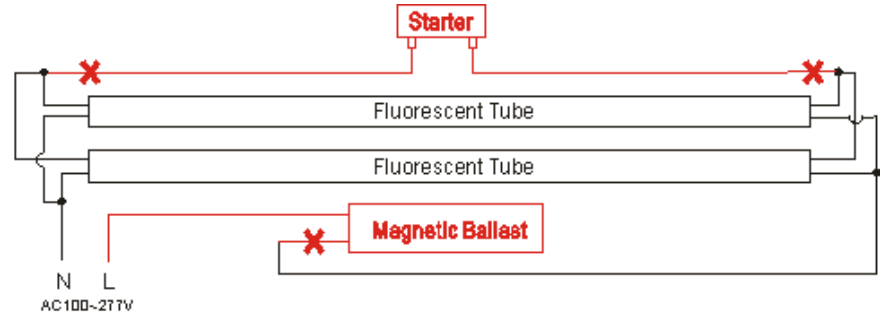

B
Electronic Ballast

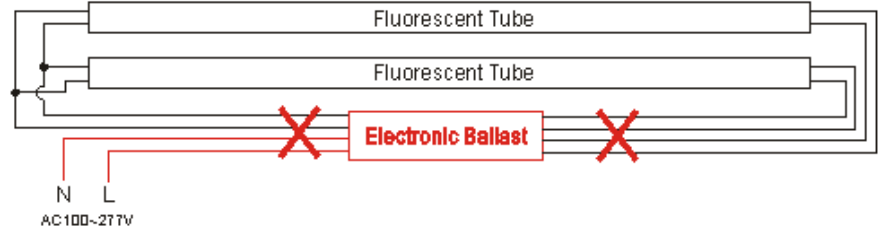

C
Instant Start Ballast

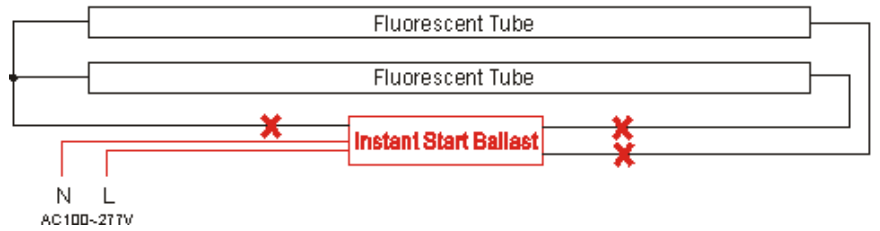

Step 5: Connect the live and neutral wires to the proper sides of the G13 sockets at the fixture separately as shown below. Make sure any wire connections are wire nudded and wrapped with electrical tape, and make sure the fixture is properly grounded before reassembling the fixture.

A
Magnetic/Inductive Ballast
w/ Starter

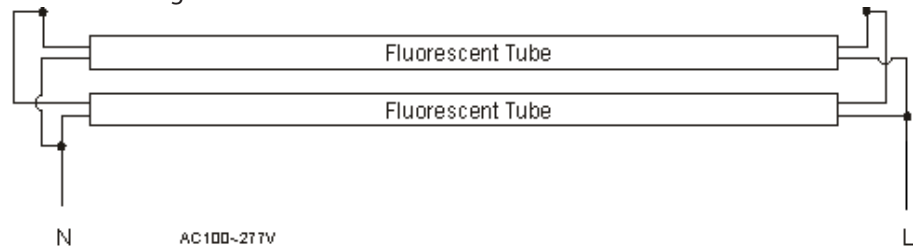

B
Electronic Ballast

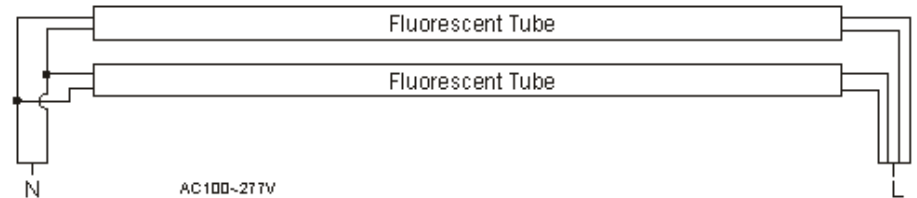

C
Instant Start Ballast

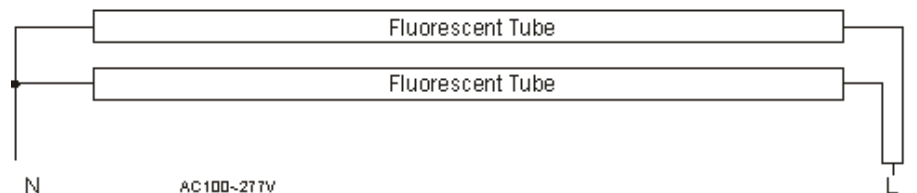

Step 6: Install your new LED tubes in the fixture and...

Have a greener lighting!